

Capasso
 **LAB**

DISTRIBUTORE
AUTORIZZATO

Visibili da CAPASSO LAB
Via Cassia, 1777
00123 Roma
+39 328 092 8680
info-contactform@capassolab.it

GRATE

 **GFP**
INFISSI 

Visibili da CAPASSO LAB
Via Cassia, 1777
00123 Roma
+39 328 092 8680
info-contactform@capassolab.it



GRATA FISSA



GFP GRATA MOD. PROCIDA

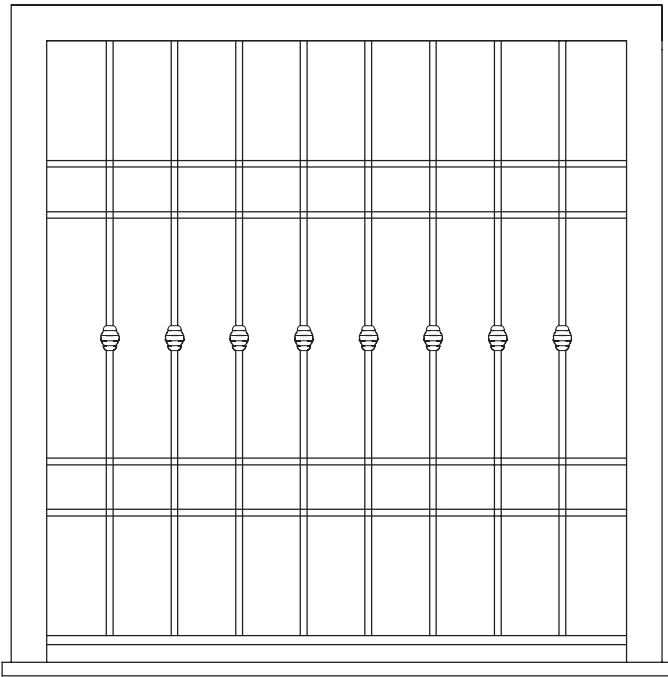

Telaio bombato di serie

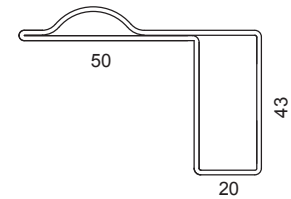

Telaio liscio a richiesta

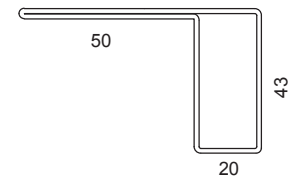

Telaio pressopiegato a richiesta

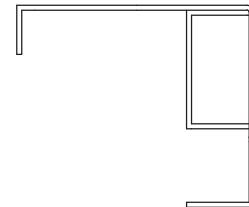

CARATTERISTICHE TECNICHE

DI SERIE

- Telaio con profilo a Z bombato sp. 15/10.
- Regoli per ancoraggio.
- Tondino Ø 14

OPTIONAL A RICHIESTA

- Telaio con profilo a Z liscio 15/10 .
- Telaio in lamiera pressopiegata 20/10 .
- Telaio personalizzato.
- Imbotte di misura varia

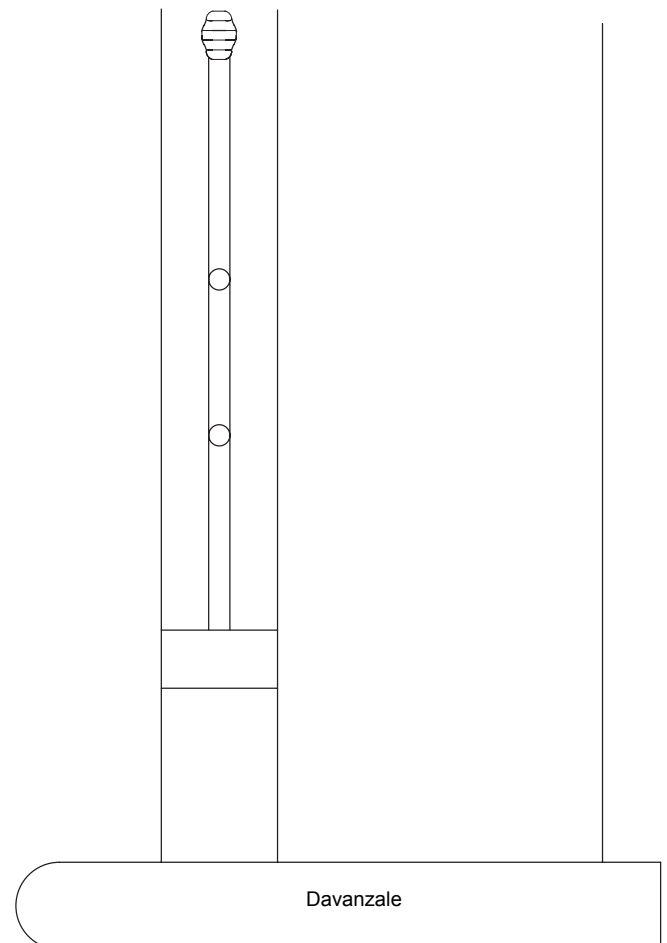

GRATA FISSA

GFP GRATA MOD. PIMONTE

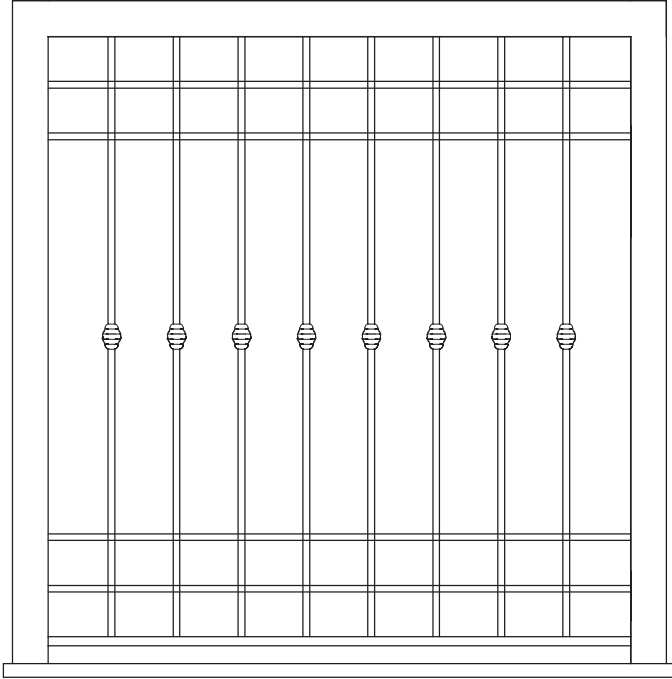

GFP GRATA MOD. SALERNO

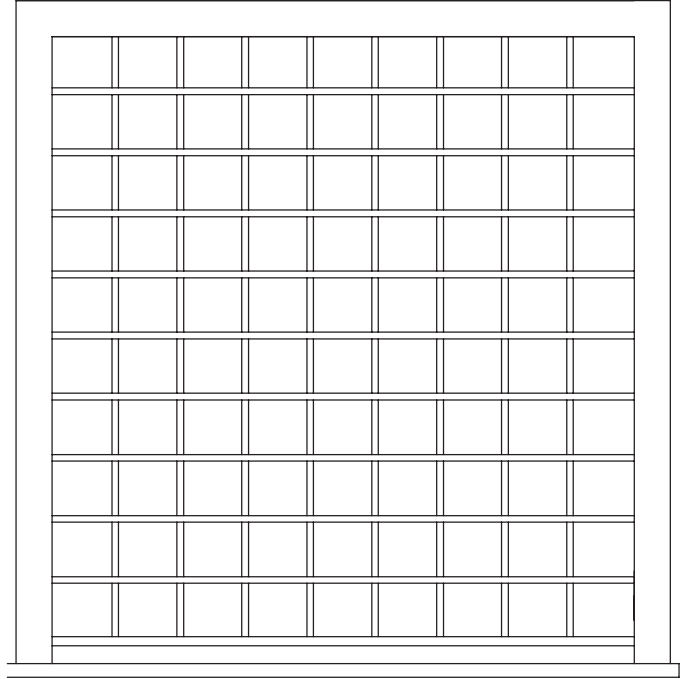

GFP GRATA MOD. NAPOLI

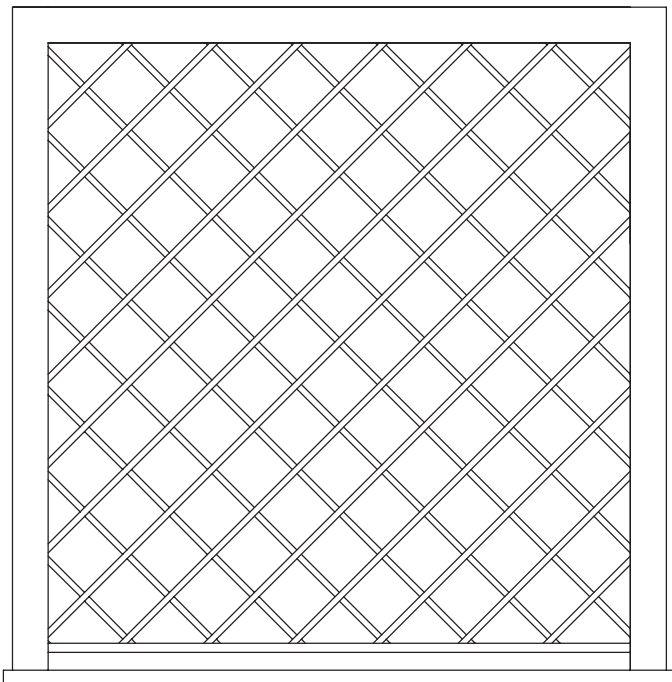

GFP GRATA MOD. AMALFI

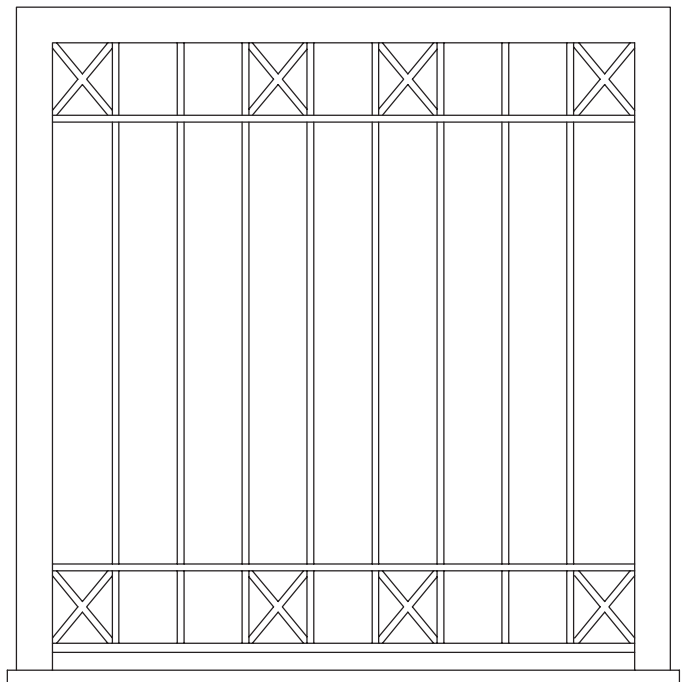

GFP GRATA MOD. MILANO

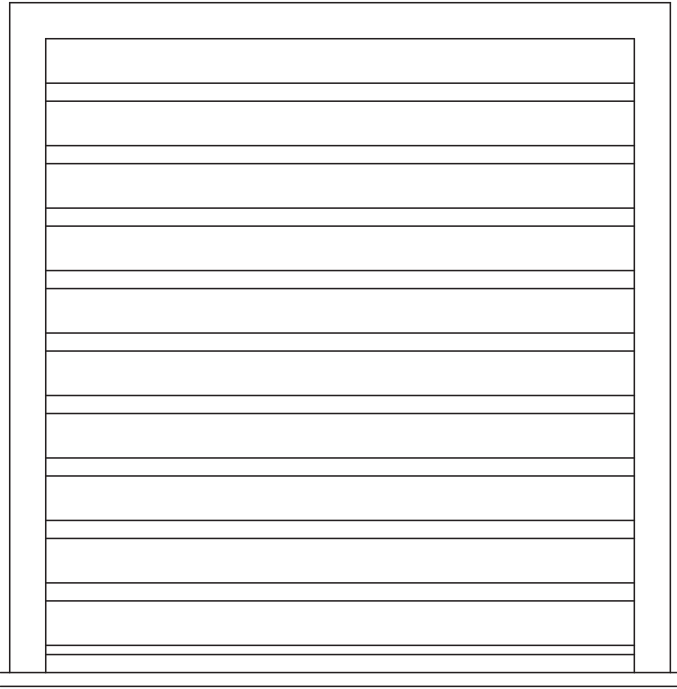

Telaio bombato di serie

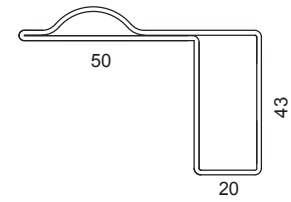

Telaio liscio a richiesta

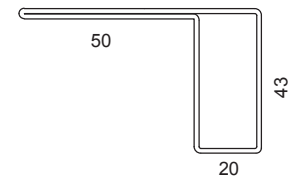

Telaio pressopiegato a richiesta

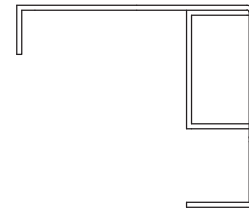

CARATTERISTICHE TECNICHE

DI SERIE

- Telaio con profilo a Z bombato sp. 15/10.
- Regoli per ancoraggio.
- Grata mod Milano e Bologna tubolare ovale 40x20
- Grata mod Capri e Roma tondino Ø 14
- Grata mod Sorrento tubolare 30x15

OPTIONAL A RICHIESTA

- Telaio con profilo a Z liscio 15/10 .
- Telaio in lamiera pressopiegata 20/10 .
- Telaio personalizzato.
- Imbotte di misura varia

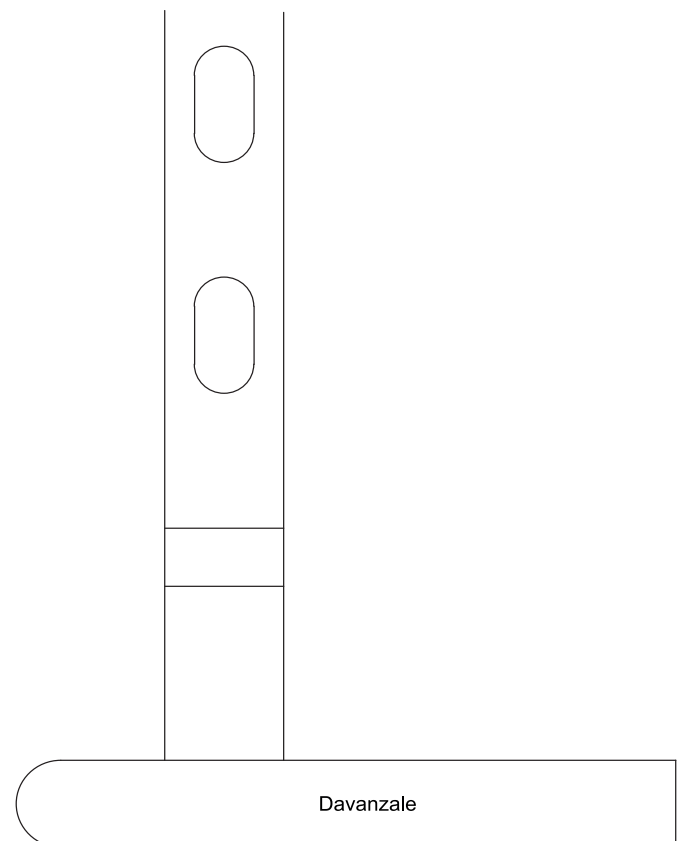

GRATA FISSA

GFP GRATA MOD. SORRENTO

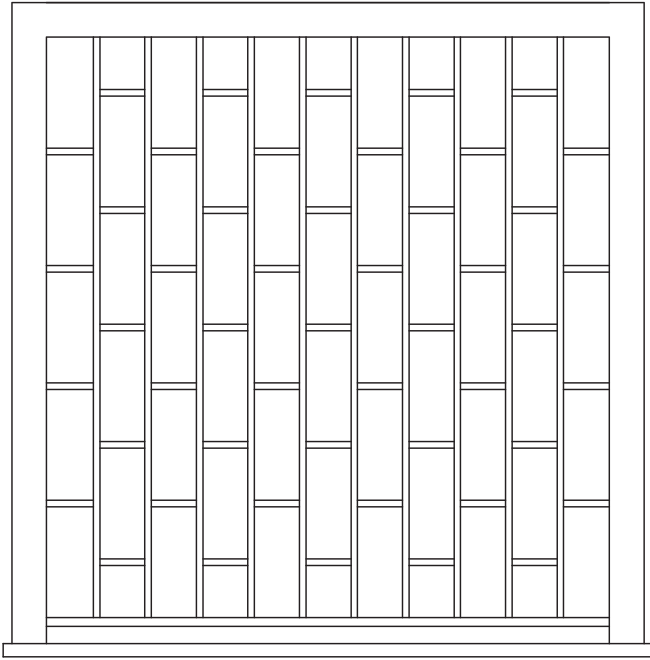

GFP GRATA MOD. CAPRI

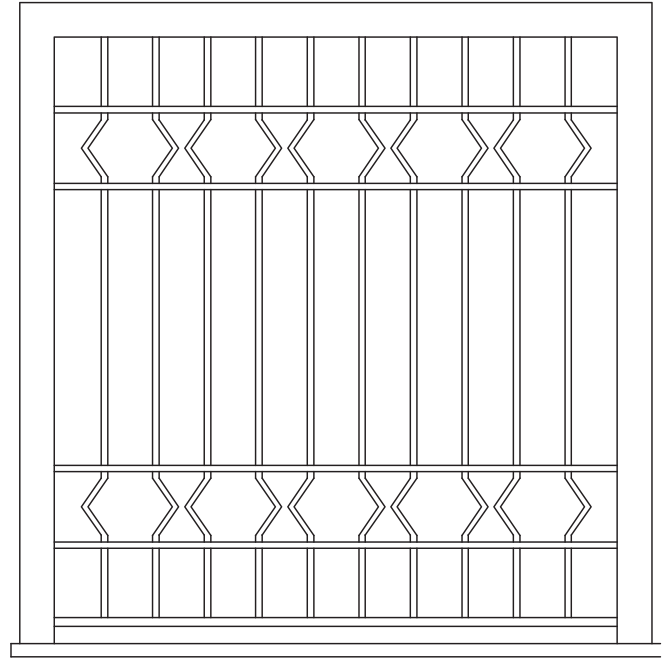

GFP GRATA MOD. ROMA

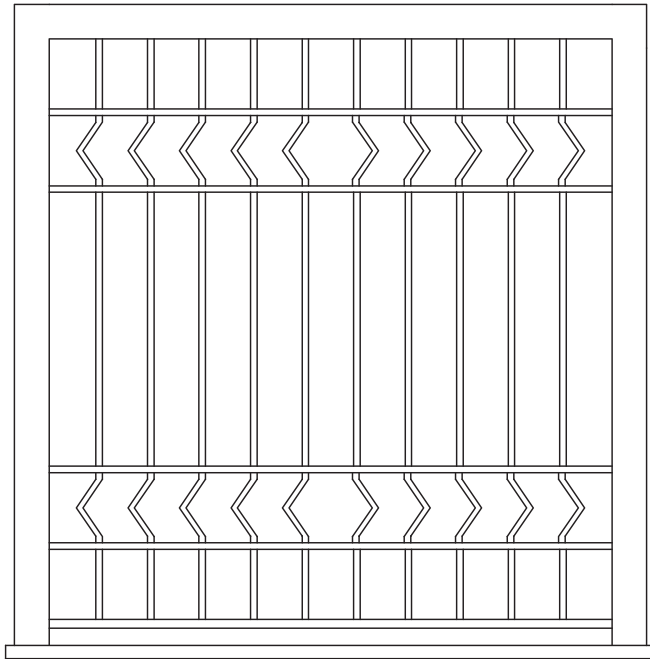

GFP GRATA MOD. BOLOGNA

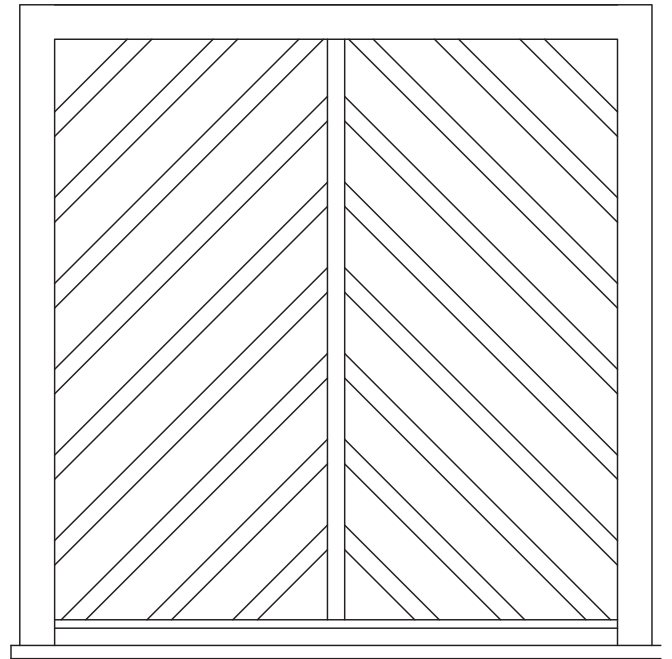

Visibili da CAPASSO LAB
Via Cassia, 1777
00123 Roma
+39 328 092 8680
info-contactform@capassolab.it



GRATA



Telaio liscio e Anta di Serie

GFP GRATA MOD. PROCIDA

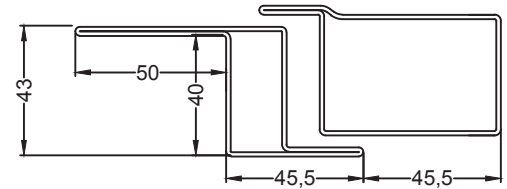
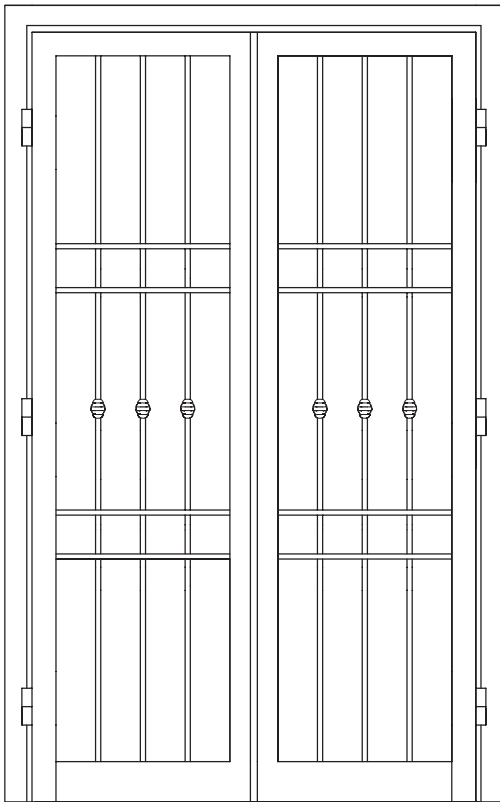

Telaio Bombato e Anta a richiesta *

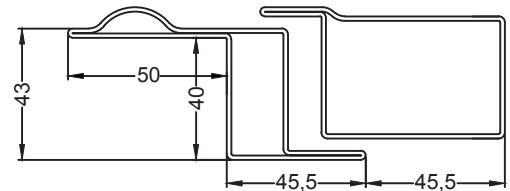

Telaio pressopiegato e Anta a richiesta

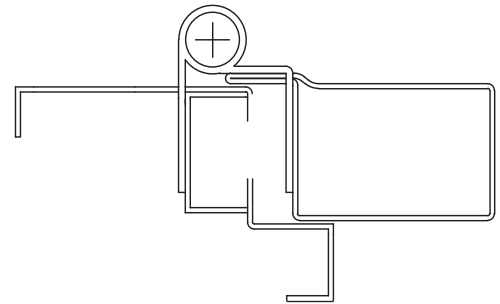

CARATTERISTICHE TECNICHE

DI SERIE

- Telaio con profilo a Z sp. 15/10.
- Regoli per ancoraggio.
- Ante con profilo 60 X 40 sp. 15/10.
- Doga Ovalina 15/10.
- Cerniere maggiorate con cuscinetto ad incassosu telaio e anta.
N. 3 per Portafinestra e n. 2 per Finestra.
- Rostri anti strappo (n. 3 per portafinestra e n. 2 per finestra).
- Tappi copri foro anti strappo sul telaio.
- Paletti a leva su seconda anta.
- Serratura a profilo con tre punti di chiusura,
con bascula centrale e puntali in acciaio superiore
e inferiore di diametro 10 mm.
- Contropiastre.
- Mezzo cilindro europeo.
- Maniglia di colore nero.
- Traverso a U 40 X 20 inferiore.

OPTIONAL A RICHIESTA

- Telaio con profilo a Z Bombato 15/10 .
- Telaio in lamiera pressopiegata 20/10 .
- Telaio personalizzato.
- Maniglia passante.
- Cilindro passante.
- Imbotte di misura varia.

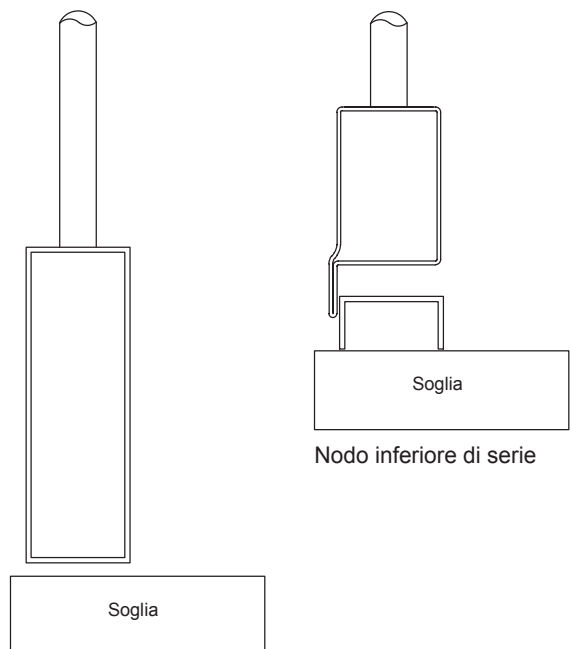

Nodo inferiore a richiesta*

* A RICHIESTA MA NON COMPORTA COSTI AGGIUNTIVI

GFP GRATA MOD. PIMONTE

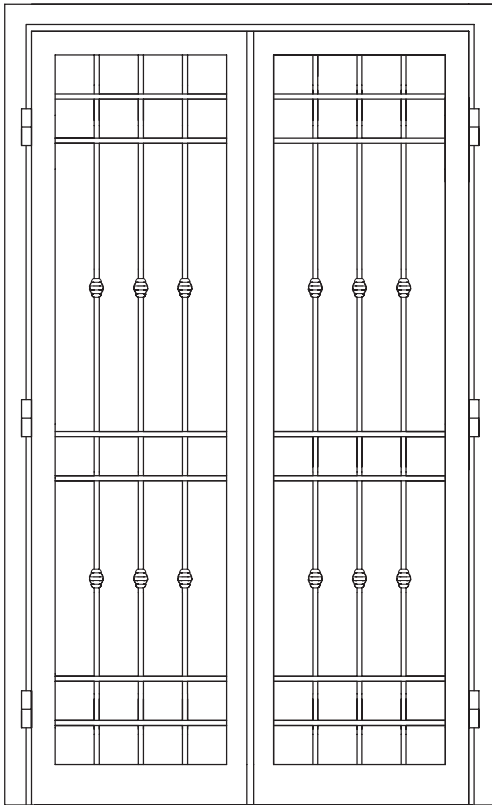

GFP GRATA MOD. SALERNO

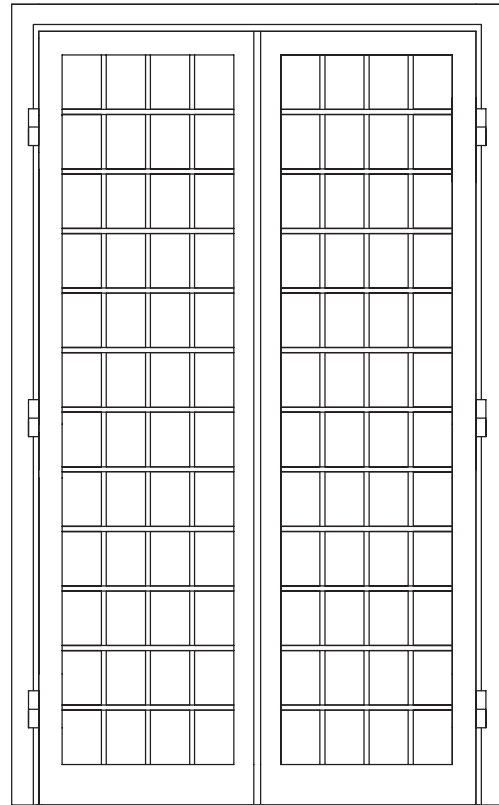

GFP GRATA MOD. NAPOLI

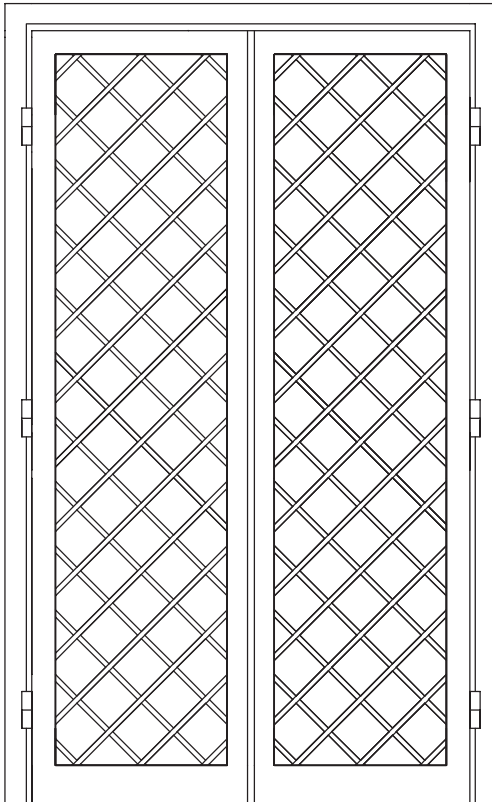

GFP GRATA MOD. AMALFI

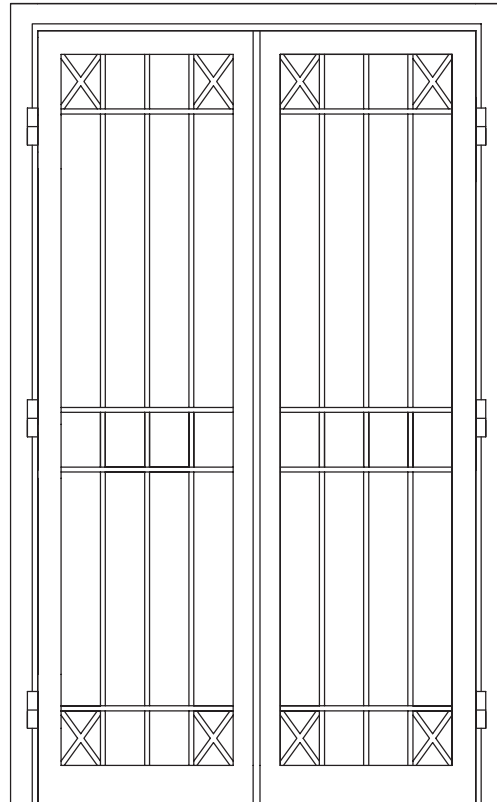

Telaio liscio e Anta di Serie

GFP GRATA MOD. MILANO

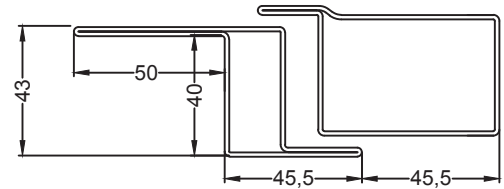
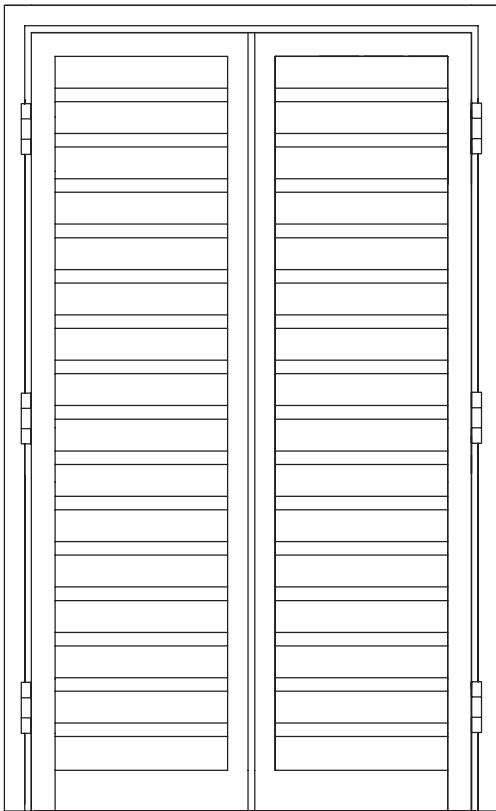

Telaio Bombato e Anta a richiesta *

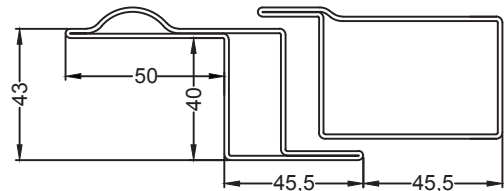

Telaio pressopiegato e Anta a richiesta

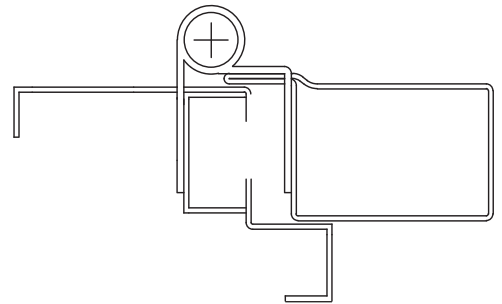

CARATTERISTICHE TECNICHE

DI SERIE

- Telaio con profilo a Z bombato sp. 15/10
- Regoli per ancoraggio
- Ante con profilo 60 X 40 sp 15/10
- Cerniere maggiorate con cuscinetto ad incasso su telaio e anta
- N. 3 per Portafinestra e n. 2 per Finestra
- Rostri anti strappo (n. 3 per portafinestra e n. 2 per finestra)
- Tappi copri foro anti strappo sul telaio
- Paletti a leva su seconda anta
- Serratura a profilo con tre punti di chiusura, con bascula centrale e puntali in acciaio superiore e inferiore di diametro 10 mm
- Contropiastre
- Mezzo cilindro europeo
- Maniglia di colore nero
- Grata mod Milano e Bologna tubolare ovale 40x20
- Grata mod Capri e Roma tondino Ø 14
- Grata mod Sorrento tubolare 30x15

OPTIONAL A RICHIESTA

- Telaio con profilo a Z liscio 15/10
- Telaio in lamiera pressopiegata 20/10
- Telaio personalizzato
- Maniglia passante
- Cilindro passante
- Traverso a U 40 X 20 inferiore
- Imbotte di misura varia

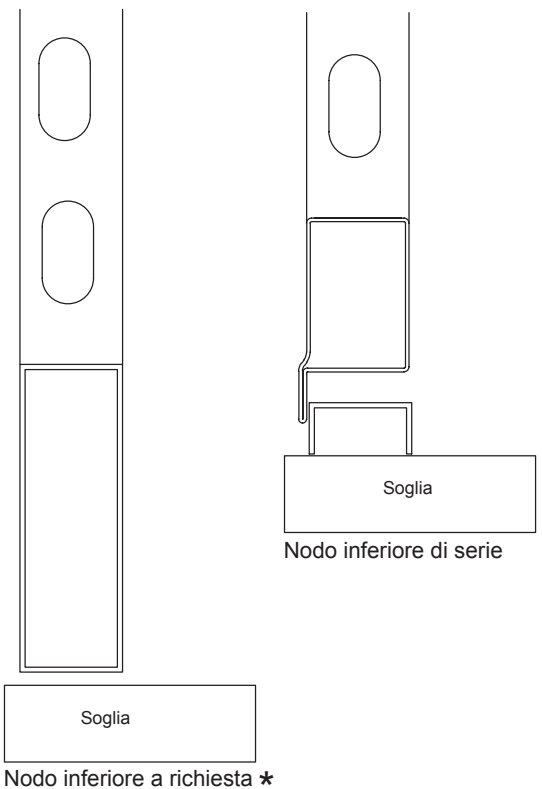

*** A RICHIESTA MA NON COMPORTA COSTI AGGIUNTIVI**

GFP GRATA MOD. SORRENTO

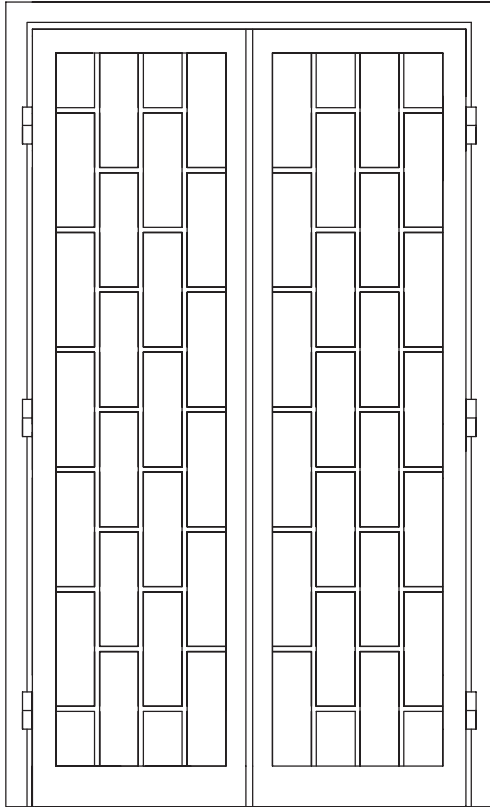

GFP GRATA MOD. ROMA

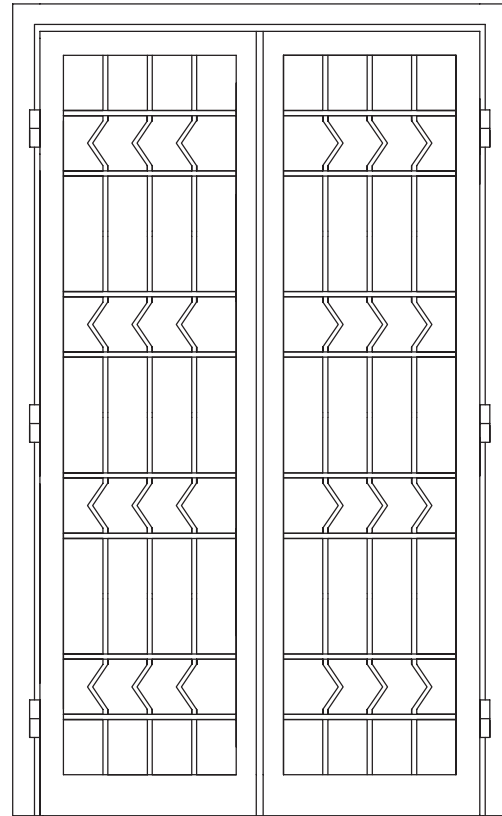

GFP GRATA MOD. CAPRI

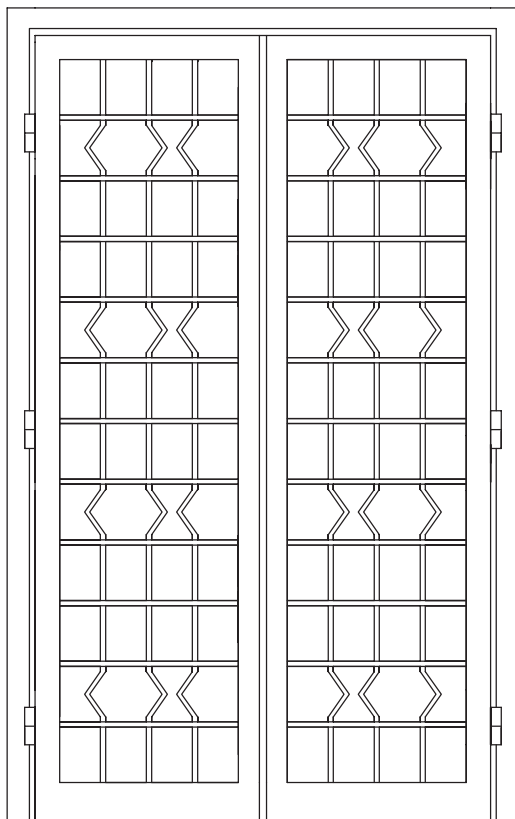

GFP GRATA MOD. BOLOGNA

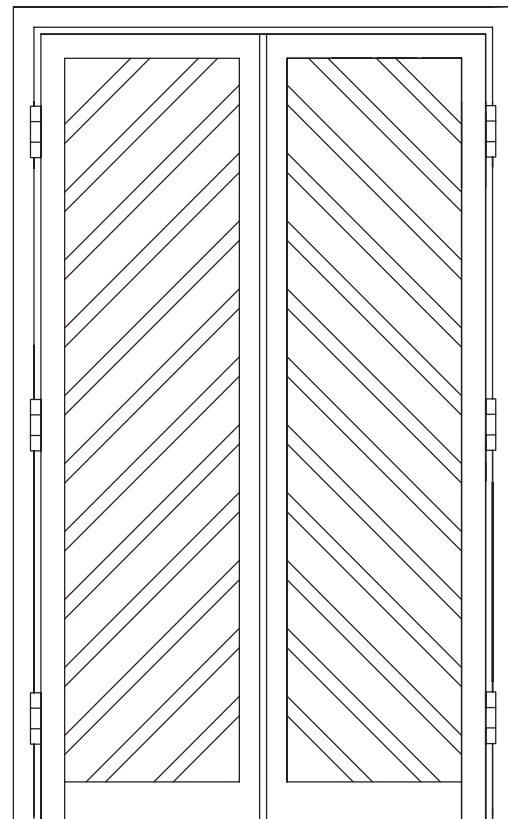

GFP GRATA A DOPPIA APERTURA MOD. ROMA

Visibili da CAPASSO LAB
Via Cassia, 1777
00123 Roma
+39 328 092 8680
info-contactform@capassolab.it

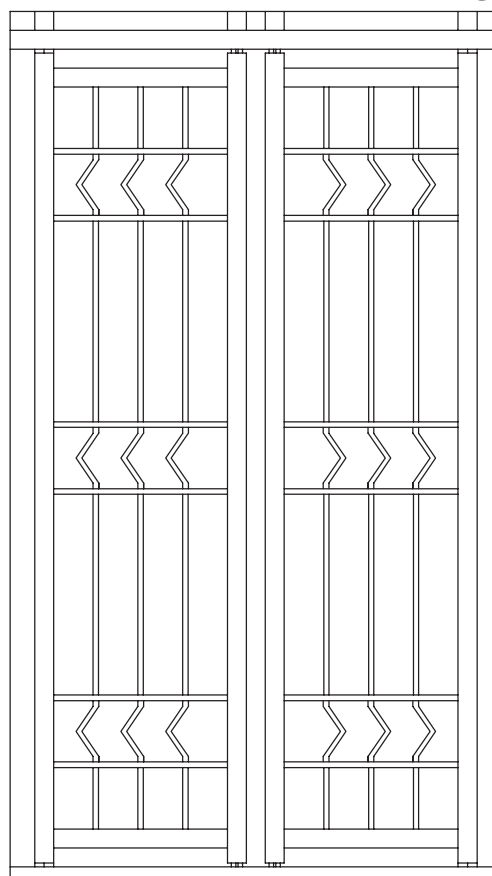

GFP GRATA A DOPPIA APERTURA MOD. PROCIDA

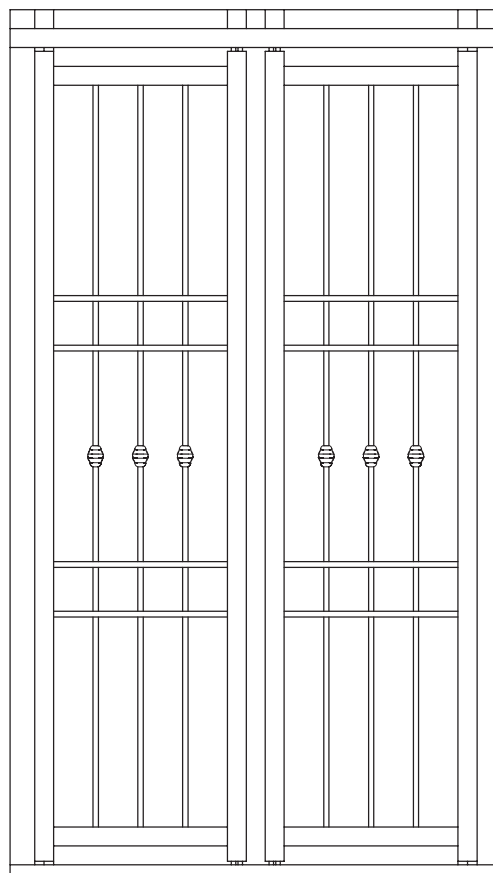

CARATTERISTICHE TECNICHE

DI SERIE

- Telaio con profilo 50X30 sp. 20/10
- Ante con profilo 50X30 sp 20/10
- Cerniere a scomparsa
- Doppia serratura a profilo con due punti di chiusura, puntali in acciaio superiore e inferiore di diametro 10 mm
- Contropiastre
- Mezzo cilindro europeo
- Maniglia di colore nero
- Grata mod. Roma e Procida tondino Ø 14

GRATA
dentro fuori

VISTA IN PIANTA GRATA CHIUSA

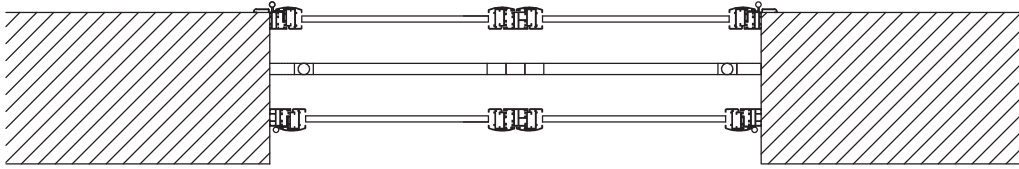

VISTA IN PIANTA GRATA APERTA VERSO L'ESTERNO

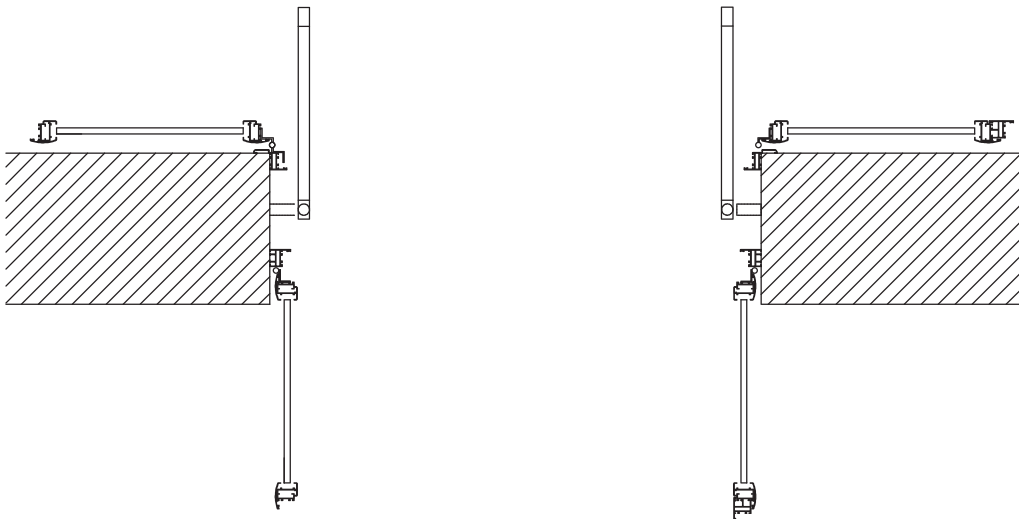

VISTA IN PIANTA GRATA APERTA VERSO L'INTERNO



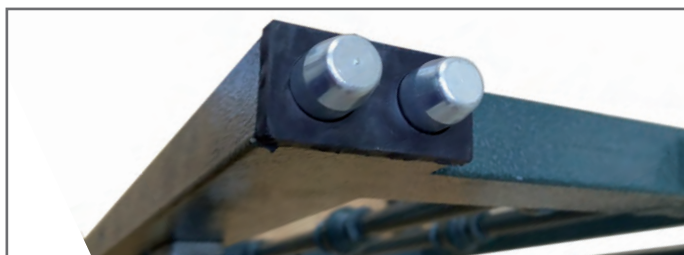

GFP GRATA A DOPPIA APERTURA SNODABILE MOD. ROMA

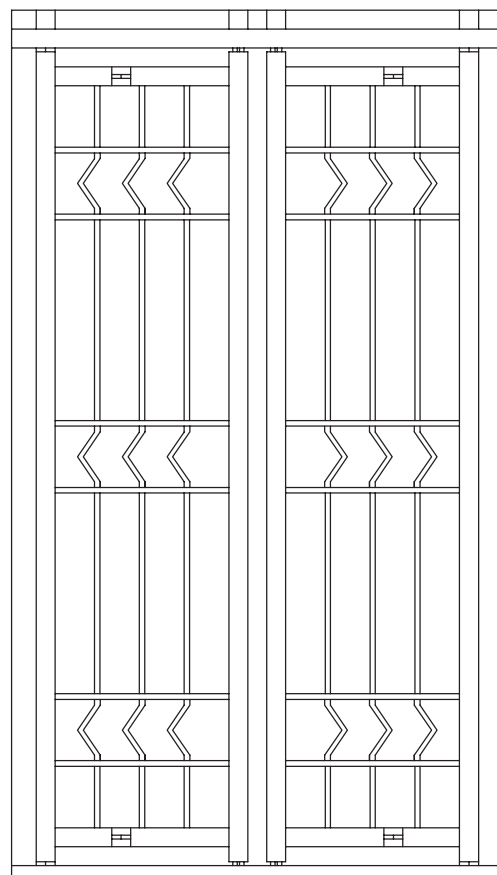

GFP GRATA A DOPPIA APERTURA MOD. PROCIDA

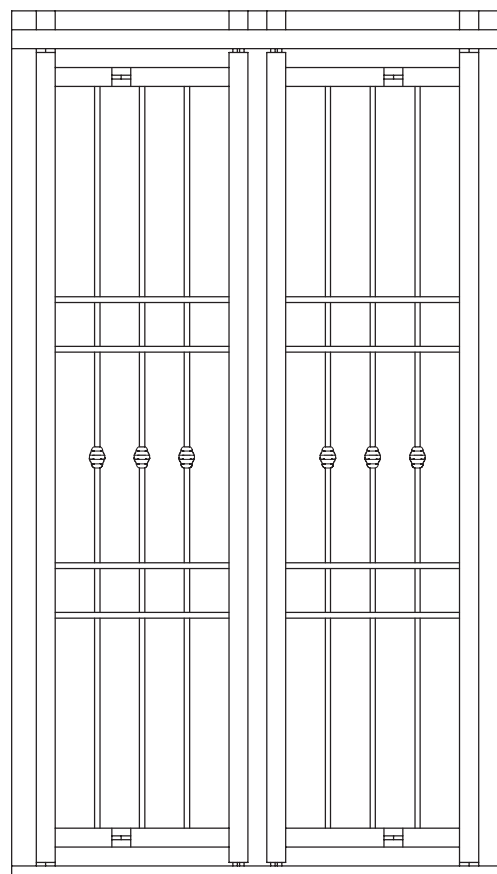

CARATTERISTICHE TECNICHE

DI SERIE

- Telaio con profilo 50X30 sp. 20/10
- Ante con profilo 50X30 sp 20/10
- Cerniere a scomparsa
- Doppia cerniera centrale per apertura snodabile
- Doppia serratura a profilo con due punti di chiusura, puntali in acciaio superiore e inferiore di diametro 10 mm
- Contropiastre
- Mezzo cilindro europeo
- Maniglia di colore nero
- Grata mod. Roma e Procida tondino Ø 14

GRATA
dentro fuori a snodo

Visibili da CAPASSO LAB

Via Cassia, 1777

00123 Roma

+39 328 092 8680

info-contactform@capassolab.it

VISTA IN PIANTA GRATA CHIUSA

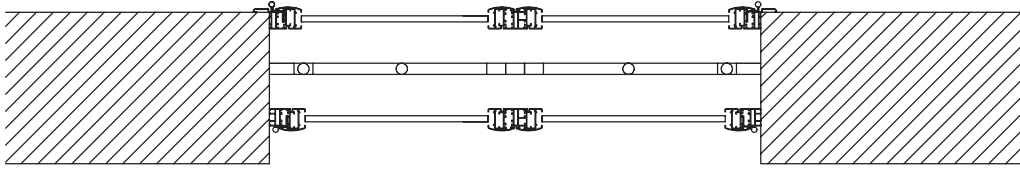

VISTA IN PIANTA GRATA APERTA VERSO L'ESTERNO

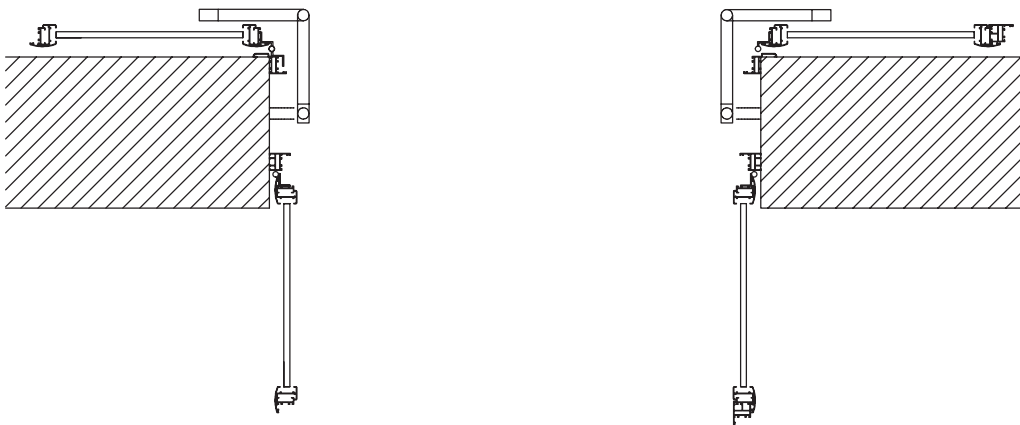

VISTA IN PIANTA GRATA APERTA VERSO L'INTERNO

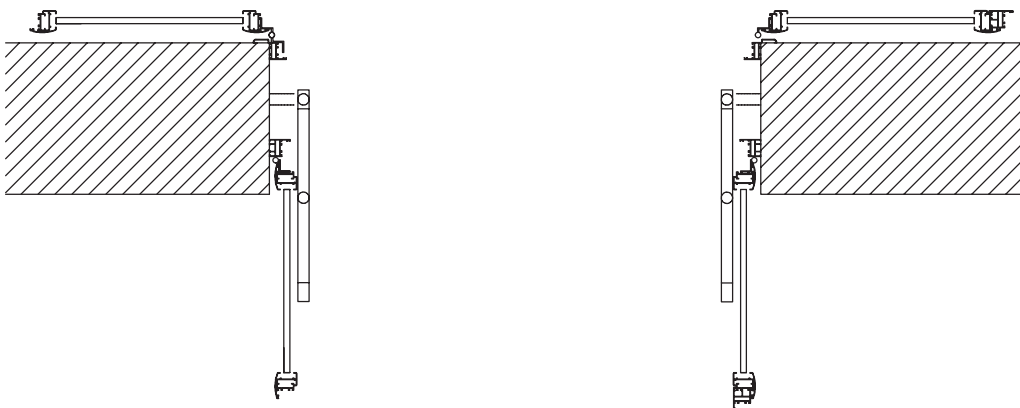



Capasso
 LAB

Visibili da CAPASSO LAB
Via Cassia, 1777
00123 Roma
+39 328 092 8680
info-contactform@capassolab.it